



GalvinCare[®] Mental Health Tapware

PRODUCT CODES:

- 50140



WaterMark
AS/NZS 3718 Lic. WMKA0034
SAI Global

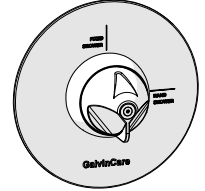

SPECIFICATIONS

- This products unique design concept eliminates the institutional look and provides anti-ligature features and vandal resistant compliance while withstands heavy knocks
- The paddle design handle allows the diverter to be activated with minimal effort.
- The 170mm round faceplate has a polished stainless steel finish for a homely look
- This item is designed for wall installation with bevelled edges provide tight fixing

IMPORTANT: All GalvinCare[®] mental health taps are tested in accordance with AS/NZS 3718 and leave our premises in good working order. **The following instructions must be followed in all respects** and read in conjunction with Clinimix[®] Progressive Thermostatic Mixing Valve Manual

TECHNICAL DATA

Inlet	1/2" BSP – Female	
Outlet	1/2" BSP – Male	
Headwork	Diverter Cartridge	
Working Pressure Range (kPa)	Min	50
	Max	500
Working Temperature Range (°C)	Min	5
	Max	90
Finish	Chrome / Polished St/St	

NOTE: Galvin Specialised continually strive to improve their products. Specifications may change without notice.

PRE-INSTALLATION

MOUNTING DETAILS – ROUGH IN & OVERALL DIMENSIONS

- Suitable for in-wall mounting
- Drill Ø6.5mm hole as shown for Anti-Rotation pin.

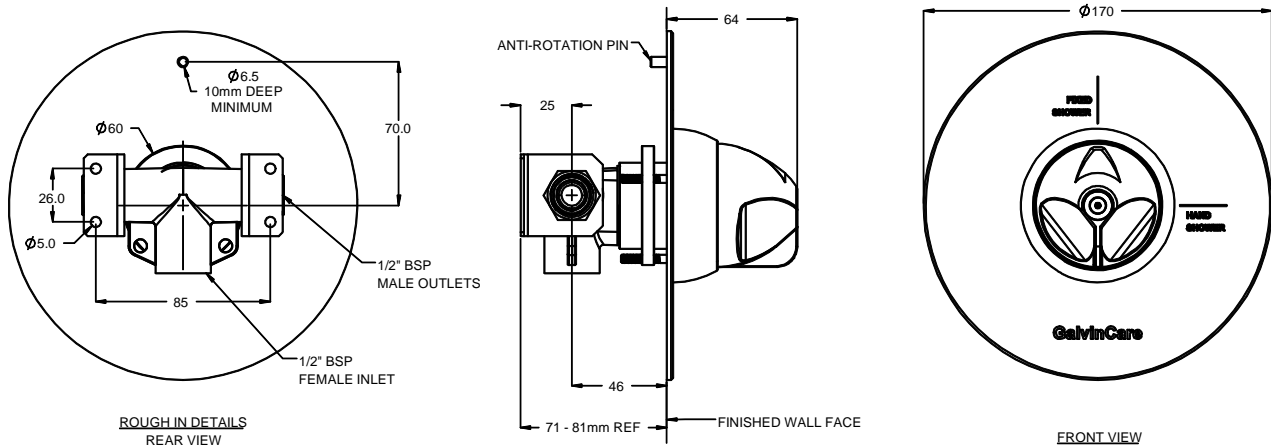

INSTALLATION

INSTALLATION COMPLIANCE: Galvin Specialised products must be installed in accordance with these installation instructions and in accordance with AS/NZS 3500, the PCA and your local regulatory requirements. Water and/or electrical supply conditions must also comply to the applicable national and/or state standards. Failing to comply with these provisions shall void the product warranty and may affect the performance of the product.

IMPORTANT: Whilst our product designs take into account a broad range of installation types and surfaces, it is important that surfaces which fixtures are mounted to are flat and free from defect. This is especially important when installing product ranges that have been designed for correctional and health facilities, where special attention is required to minimise ligature points and areas for concealment of contraband. In addition to ensuring the products are fitted securely and in accordance with the following instructions, consideration shall be given to the use of non-pick mastics such as BASF Sonolastic "Ultra" to ensure a high quality and safe installation.

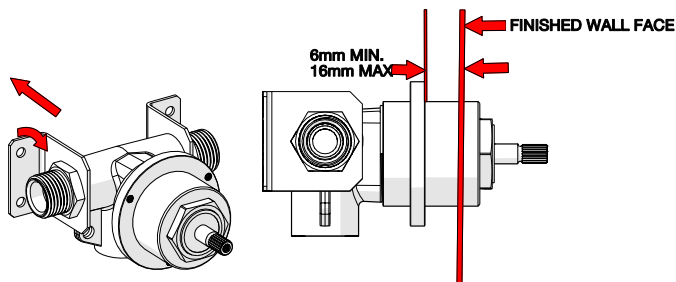

1. Fit body assembly

- Secure body with mounting brackets as indicated, ensure it is protruding past the finished wall between 6mm min and 16mm max
- Brackets are suitable for horizontal and vertical mounting.
- It is critical that the centre line of the cartridge spindle is perpendicular to the finished wall to ensure correct fitment of the faceplate and flange

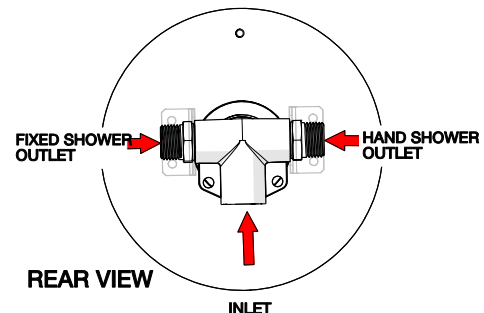

2. Connect water supply

- Connect water supply to correct inlet as shown, ensure a suitable sealing compound is used
- Connect correct outlet connection to shower outlets.

Note: Water supply should be flushed before fitting. The use of in-line strainers is highly recommended.

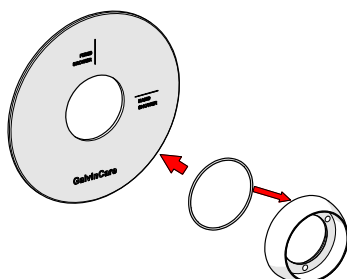

3. Fit faceplate & flange

- Fit supplied o-ring into the groove on the back of the flange.
- Fit faceplate on to shoulder of flange.

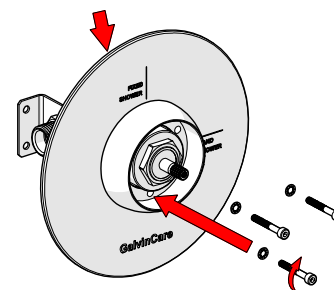

4. Secure flange

- Slide faceplate and flange onto the body. Secure with three M4 cap screws and lock washers, ensure the faceplate anti-rotation pin is pushed through the Ø6.5mm hole.

Note: Cartridge spline must be parallel with the faceplate within 1°.

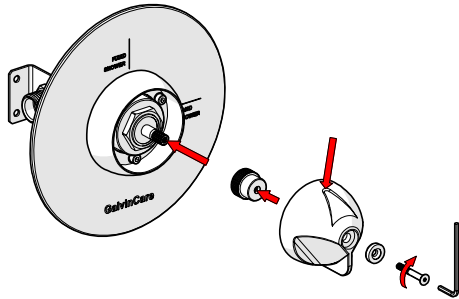

5. Fit the handle

- Fit the nylon insert and handle, ensuring the arrow on the handle matches the lines on the faceplate when rotated.
- Secure handle with the tamper proof screw.

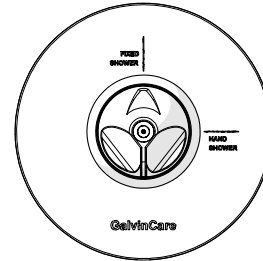

6. Testing

- Once fitted turn on water and check for leaks and correct operation.

TROUBLESHOOTING

PROBLEM	CAUSE	RECTIFICATION
Faceplate does not sit flush on wall	Diverter not mounted perpendicular to wall	Remove and re-mount so the body is perpendicular to finished wall
Handle rubs against the flange	The faceplate is not perpendicular to cartridge spline within 1°.	Remove and re-mount properly ensuring faceplate is within 1° perpendicular to cartridge spline.
Water flow does not match faceplate markings	Handle not aligned correctly to faceplate	Remove handle and rotate on the spline until handle matches faceplate. Re-tighten
	Outlet on body not connected to the correct service outlet	Change outlet connection on body

SERVICE AND MAINTENANCE

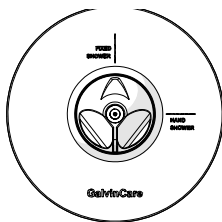

1. Turn off water

- Turn off the water supply
- Open shower outlet to release pressure

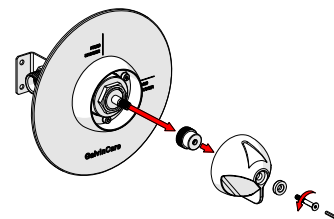

2. Remove handle assembly

- Unscrew tamper proof screw from handle
- Pull out handle assembly from the body

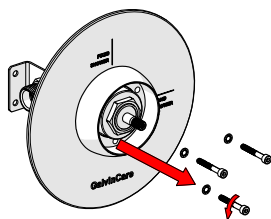

3. Remove flange screws

Unscrew the flange screws

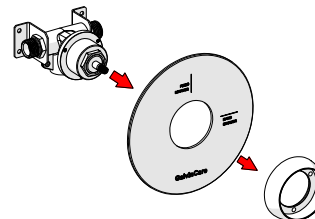

4. Remove faceplate and flange

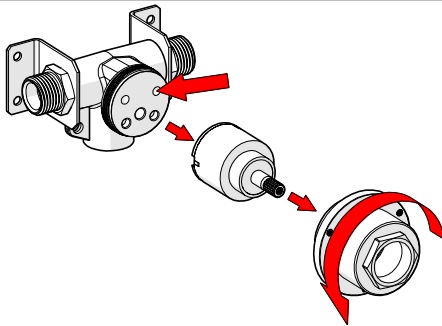

5. Remove cartridge nut and check cartridge

- Unscrew cartridge nut and remove cartridge.
- Check the cartridge for wear and damage. Replace if required with cartridge replacement available through your supplier
- Check and clean the body of all debris

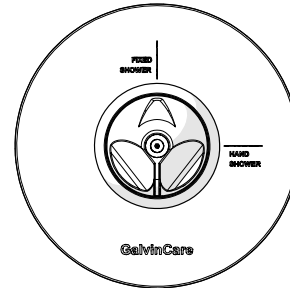

6. Re-assemble

- Re-assemble, by reversing steps 5 to 1.
- Turn on water and check for correct operation

WARRANTY

The warranty set forth herein is given expressly and is the only warranty given by the Galvin Engineering Pty Ltd. With respect to the product, Galvin Engineering Pty Ltd makes no other warranties, express or implied. Galvin Engineering Pty. Ltd. hereby specifically disclaims all other warranties, express or implied, including but not limited to the implied warranties of merchantability and fitness for a particular purpose.

Galvin Engineering Pty Ltd products are covered under our manufacturer's warranty available for download from www.galvinengineering.com.au Galvin Engineering Pty Ltd expressly warrants that the product is free from operational defects in workmanship and materials for the warranty period as shown on the schedule in the manufacturer's warranty. During the warranty period, Galvin Engineering will replace or repair any defective products manufactured by Galvin Engineering without charge, so long as the terms of the Manufacturer's warranty are complied with.

The remedy described in the first paragraph of this warranty shall constitute the sole and exclusive remedy for breach of warranty, and Galvin Engineering Pty Ltd shall not be responsible for any incidental, special or consequential damages, including without limitation, lost profits or the cost of repairing or replacing other property which is damaged if this product does not work properly, other costs resulting from labour charges, delays, vandalism, negligence, fouling caused by foreign material, damage from adverse water conditions, chemical, electrical or any other circumstances over which Galvin Engineering has no control. This warranty shall be invalidated by any abuse, misuse, misapplication, improper installation or improper maintenance or alteration of the product.

